

圆柱型光电传感器

LL18系列



特

标准偏光的镜片反射型

密封性为IP67的一体成型结构

点

外壳材质为PBT塑料和铜镀镍两种

统一标配柔软线

应用

抗阳光型检测

M18常用型光电传感器,多种型号可选择,可以定制抗阳光型。







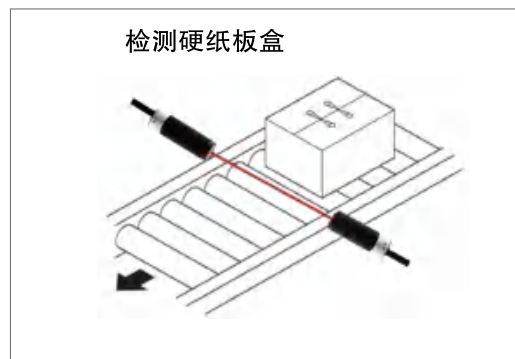

检测纸盒

通用圆型光电传感器可应用于传送带上非透明物体的检测,如:检测硬纸板盒。

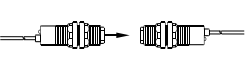
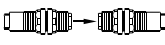
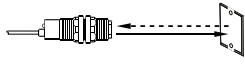
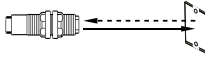

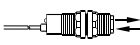

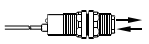

LL18圆形光电传感器,体积小、检测距离5cm、15cm、500cm。

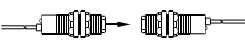
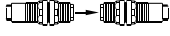
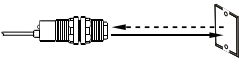
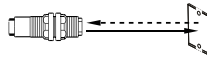

LL18系列光电传感器

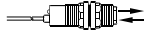
类型	设计	外观	检测距离	输出模式	型号		光源 (LED)	缆线
					NPN	PNP		
对射型			15m	NO.NC	LL18-T1500N	LL18-T1500P	红外光	Φ4×2M/2-wires Φ4×2M/3-wires
			15m	NO.NC	LL18-T1500N-M	LL18-T1500P-M	红外光	M12接插件
回归反射型			3m	NO.NC	LL18-R300NC	LL18-R300PC	红外光	Φ4×2M/4-wires
			3m	NO.NC	LL18-R300NC-M	LL18-R300PC-M	红外光	M12接插件
漫反射型	塑料圆柱型		50cm	NO.NC	LL18-D50NC	LL18-D50PC	红外光	Φ4×2M/4-wires
			50cm	NO.NC	LL18-D50NC-M	LL18-D50PC-M	红外光	M12接插件
			10cm	NO.NC	LL18-D10NC	LL18-D10PC	红外光	Φ4×2M/4-wires
			10cm	NO.NC	LL18-D10NC-M	LL18-D10PC-M	红外光	M12接插件
限定反射型			10cm	NO.NC	LL18-DS10NC	LL18-DS10PC	红 光	Φ4×2M/4-wires
			10cm	NO.NC	LL18-DS10NC-M	LL18-DS10PC-M	红 光	M12接插件

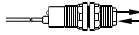
LL18系列光电传感器

类型	设计	外观	检测距离	输出模式	型号		光源 (LED)	缆线
					NPN	PNP		
对射型			15m	NO.NC	LL18M-T1500N	LL18M-T1500P	红外光	Φ4 × 2M/2-wires Φ4 × 2M/3-wires
			15m	NO.NC	LL18M-T1500N-M	LL18M-T1500P-M	红外光	M12接插件
回归反射型			3m	NO.NC	LL18M-R300NC	LL18M-R300PC	红外光	Φ4 × 2M/4-wires
			3m	NO.NC	LL18M-R300NC-M	LL18M-R300PC-M	红外光	M12接插件
漫反射型	金属圆柱型		50cm	NO.NC	LL18M-D50NC	LL18M-D50PC	红外光	Φ4 × 2M/4-wires
			50cm	NO.NC	LL18M-D50NC-M	LL18M-D50PC-M	红外光	M12接插件
			10cm	NO.NC	LL18M-D10NC	LL18M-D10PC	红外光	Φ4 × 2M/4-wires
			10cm	NO.NC	LL18M-D10NC-M	LL18M-D10PC-M	红外光	M12接插件
限定反射型			10cm	NO.NC	LL18RM-DS10NC	LL18RM-DS10PC	红 光	Φ4 × 2M/4-wires
			10cm	NO.NC	LL18RM-DS10NC-M	LL18RM-DS10PC-M	红 光	M12接插件

附件:

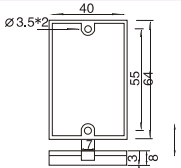
类型	外观	检测距离	型号
反射板		2m	FSB-4055

LL18系列光电传感器

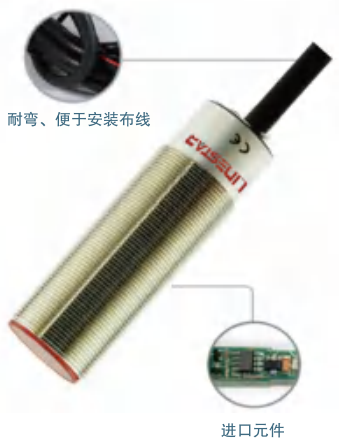

项目	规格
工作电压	12~24VDC±10%
消耗电流	15mA Max
负载电流	100mA Max at DC 24V
输出模式	NC=NPN.NO.NC PC=PNP.NO.NC
保护电路	电源反接保护及输出短路保护
响应频率	500Hz
隔离抗阻	20MΩ min. (DC500V)
绝缘耐压	AC1000V 60Hz for 60Sec
工作温度	-10°C~+50°C(不可结霜、结冰)
工作湿度	35%~85% HR 相对湿度
存储温度	-20°C~+60°C(不可结霜、结冰)
存储湿度	35%~95% HR 相对湿度
防水等级	IP67
外观材质	ABS塑料/铜镀镍

LL18系列光电传感器

电路图

NPN.NO

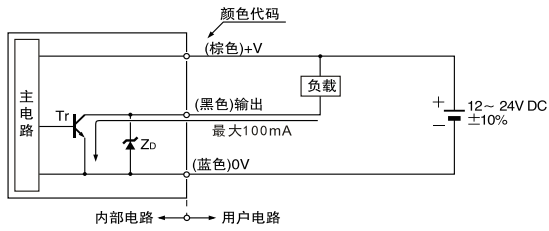

NPN.NO

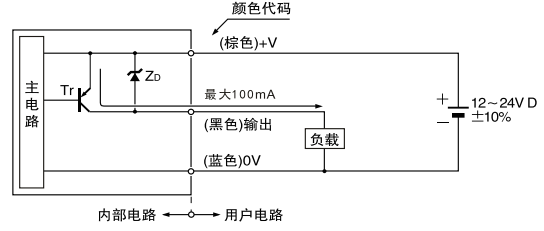

NPN.NO.NC

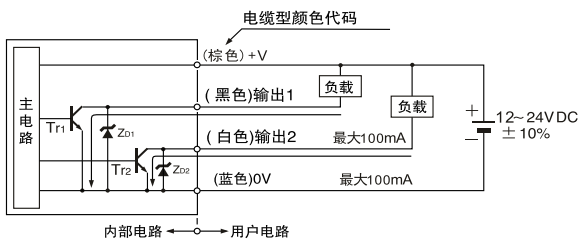

NPN.NO.NC

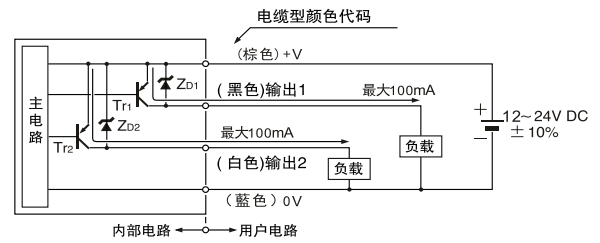

接线图

接线图 (NPN)

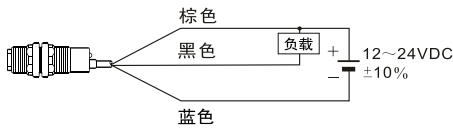

接线图 (NPN)

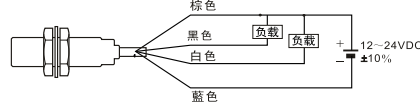

接线图 (PNP)

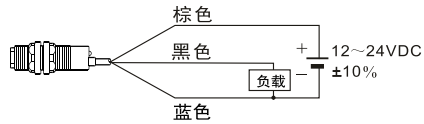

接线图 (PNP)

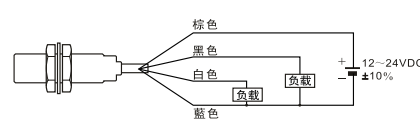

接线图(发射)

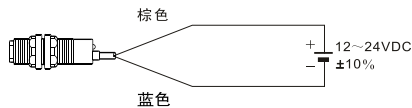

引脚布局

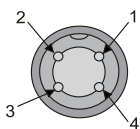

M12

1	棕
2	白
3	蓝
4	黑

LL18系列光电传感器

尺寸图 (单位: mm)

直出线光电尺寸图:

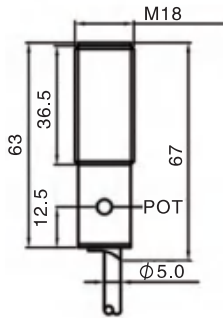

M12接插件尺寸图:

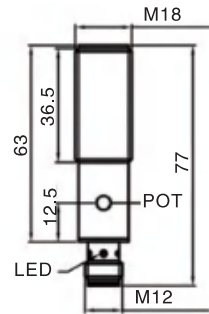

安装支架尺寸图 (单位: mm)

安装支架

